



Create a warm, welcoming ambience with superior quality lighting

MASTER LEDspot ExpertColor LV

MASTER LEDspot LV ExpertColor creates a warm and comfortable ambience for hospitality venues, homes and restaurants. It creates such an ambience with superior lighting that has a customized spectrum, high CRI, and deep dimming feature. The result? A beautiful lighting experience. What's more, the innovative, trimless lens design will suit almost any interior decor with its clean and neat look. In addition, you can take advantage of the full ExpertColor family, which also includes LEDspot MV and LEDspot Par lamps.

Benefits

- Create warm and comfortable ambience
- Interior decor, furnishings and fabrics look great
- Hassle-free retrofit solution for greater energy efficiency and sustainability

Features

- Customized color spectrum replicates halogen light color
- Trimless design with beautiful V-groove lens
- Best-in-class color realization CRI97, R9>85
- Deep and smooth dimming with broad transformer compatibility
- Retrofit with low-voltage MR16 halogen lamps with GU5.3 socket

MASTER LEDspot ExpertColor LV

Application

- Hospitality: hotel guest room, corridors, lobby, reception area, restaurants, bars, cafes
- Home: living room, bedrooms, hall way
- Retail: exhibitions, display cabinets, shops, dressing rooms

Versions



GU5.3 MR16

Dimensional drawing

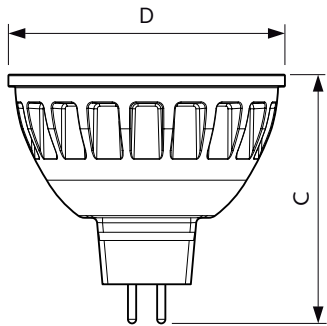

Product	D	C
MASTER LED MR16 ExpertColor 7.2-50W 927 36D	51 mm	46 mm
MASTER LED MR16 ExpertColor 7.2-50W 930 36D	51 mm	46 mm

MASTER LEDspot ExpertColor LV

Approval and Application

Energy Consumption kWh/1000 h - kWh

Controls and Dimming

Dimmable Yes

Operating and Electrical

Input Frequency - Hz
 Voltage (Nom) 12 V
 Wattage Equivalent 50 W
 Power (Rated) (Nom) 7.2 W
 Starting Time (Nom) 0.5 s

General Information

Cap-Base GU5.3
 Nominal Lifetime (Nom) 40000 h
 Switching Cycle 50000X

Light Technical

Beam Angle (Nom) 36 °
 Color Rendering Index (Nom) 97
 Llmf At End Of Nominal Lifetime (Nom) 70 %

Mechanical and Housing

Bulb Shape MR16

Temperature

T-Case Maximum (Nom) 92 °C

Light Technical

Order Code	Full Product Name	Color Code	Correlated Color Temperature (Nom)	Luminous Flux (Nom)	Luminous Intensity (Nom)
929001242508	MASTER LED MR16 ExpertColor 7.2-50W 927 36D	927	2700 K	450 lm	1350 cd
929001242608	MASTER LED MR16 ExpertColor 7.2-50W 930 36D	930	3000 K	480 lm	1450 cd

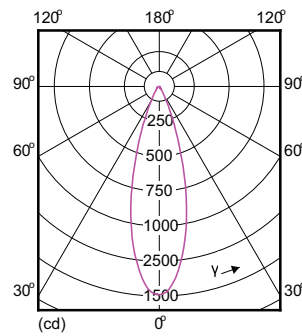
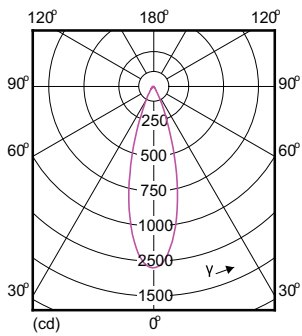

MASTER LEDspot ExpertColor LV

Accent Diagrams

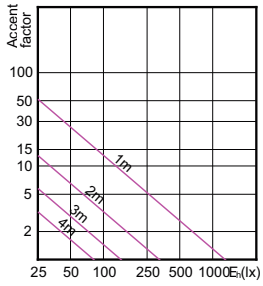

MAS LED ExpertColor 7.2-50W MR16 GU5.3 927 36D

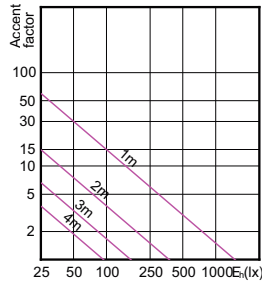

MAS LED ExpertColor 7.2-50W MR16 GU5.3 930 36D

Beam Diagrams

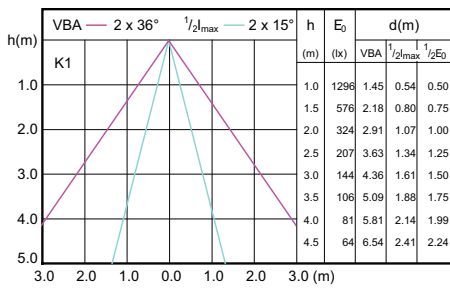

MAS LED ExpertColor 7.2-50W MR16 GU5.3 927 36D

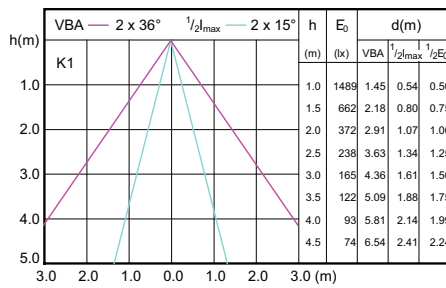

MAS LED ExpertColor 7.2-50W MR16 GU5.3 930 36D

